

# SPECIFICATIONS

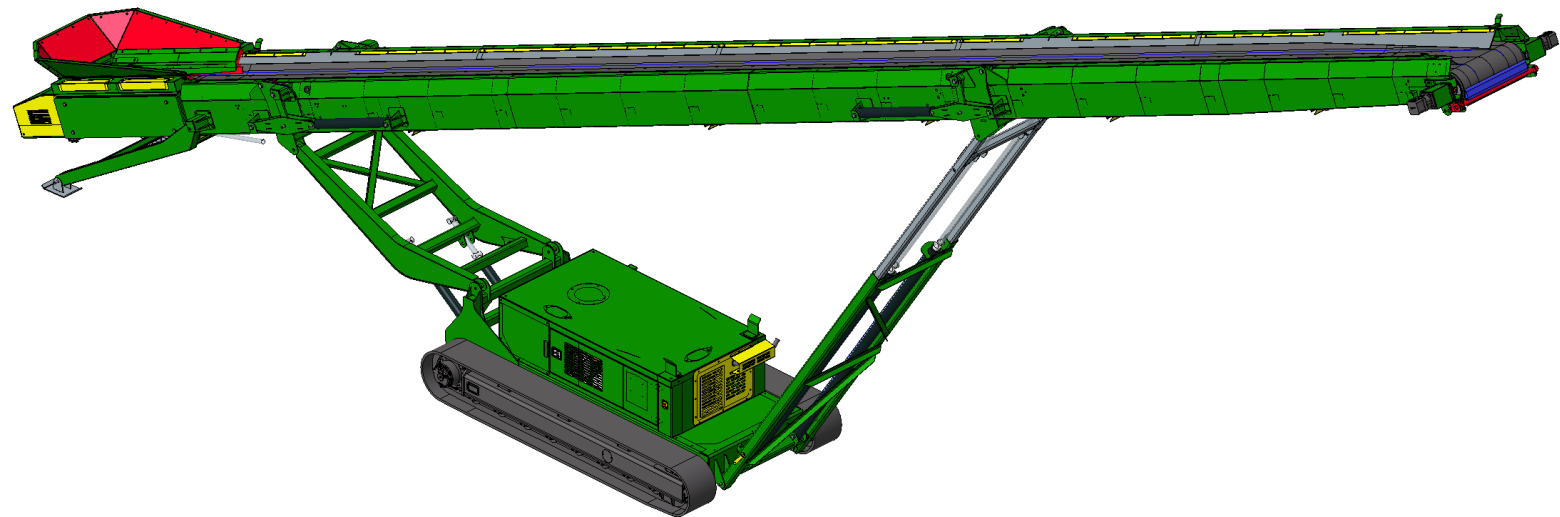

# TS4080 TRACK CONVEYOR

*Optional equipment may be shown*

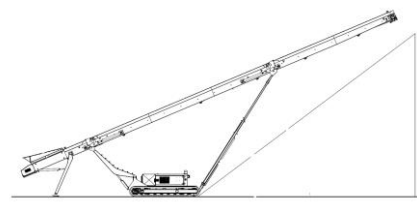

### DESCRIPTION

The newly designed TS4080 is McCloskey international's newest addition to the materials handling division. Designed to allow operators to stockpile/transfer material directly from mobile crushing and screening plants it offers the perfect solution to all your material handling needs. It offers the flexibility and mobility needed to ensure that the stockpiling process is as fast and efficient as possible, it eliminates the use of a loader and also the double handling of materials.

The unit can also be containerized for transport, with minimal setup time, substantially reducing transport costs.

The TS4080 Track Conveyor comes with the following features as standard:

- Dual hydraulic main drive system.
- Hydraulic folding heading section for transport minimizing setup time.
- Hydraulically adjustable discharge height up to 11 meters
- Hydraulically adjustable feed in height to compliment crushing and screening plants.
- 4 Meter tracks for superior maneuverability and stability.
- CAT 2.2 37KW giving a rating of up to 600 TPH.
- Fuel efficient Hydraulics system.
- Fully skirted tail section.
- User Friendly Hydraulic Controls

### DIMENSIONS AND CAPACITIES

Length – working (Max)	23.5m (77'-3")
Height – working (Max)	11.4m (37'-6")
Length – transport	11.7m (38'-8")
Width – transport	2.34m (7'-8")
Height – transport	2.6m (8'-6")
Over Hang - Transport	5.1m (16'-7")
Maximum Production Rate	600 MTPH (660 TPH)
Max Product Size	300MM ( 12") minus

### MATERIALS

Materials include but are not limited to;

- Sand and Gravel
- Aggregates
- Compost
- Topsoil
- C and D waste
- Mulch
- Coal

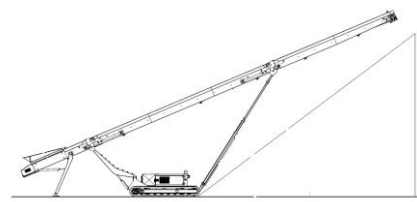

### CONVEYOR

Belt width	1000mm (40")
Belt spec	3 Ply ( 400/3 5+1.5)
Scraper	Urethane scraper as standard
Pulley Adjuster	Standard Threaded Bar
Conveyor Idlers	45 Degree angle
Return Idlers	Self-Cleaning Rubber Disc
Conveyor motor	Twin DANFOSS OMV500
Drive Drum	350mm Ø with diamond Lagging
Tail Drum	270mm Ø spoked drum

### Capacities

Hydraulic tank	285 L (75 US gal)
Diesel Tank	200 L (53 US gal)
Feeder Boot Capacity	1.1M <sup>3</sup> (1.4 Yd <sup>3</sup> )

### OPTIONS INCLUDING BUT NOT LIMITED TO;

- Dual Power Drive.
- Feed boot Rubber Liners.
- Feed boot hardox liners.
- Hydraulic Tail Fold
- Upgrade to 1000 TPH rated machine.
- Head Scraper upgrade.
- Anti-Roll backs
- Rear Hydraulic Folding Jack legs
- Extended Feed boot with crash Box.
- Radio remote control Conveyor and setup functions.
- Heavy Duty Impact Bed
- Full conveyor skirting
- Heavy duty 4 ply belt

### SAFETY FEATURES

- External belt alignment points.
- External grease points.
- Engine safety shutdown systems.
- Full safety guarding for nip points.

**TS4080**

OCT.2016.issue 000

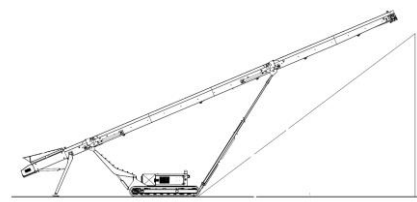

WEIGHT OF STANDARD  
MACHINE: 12700 KG

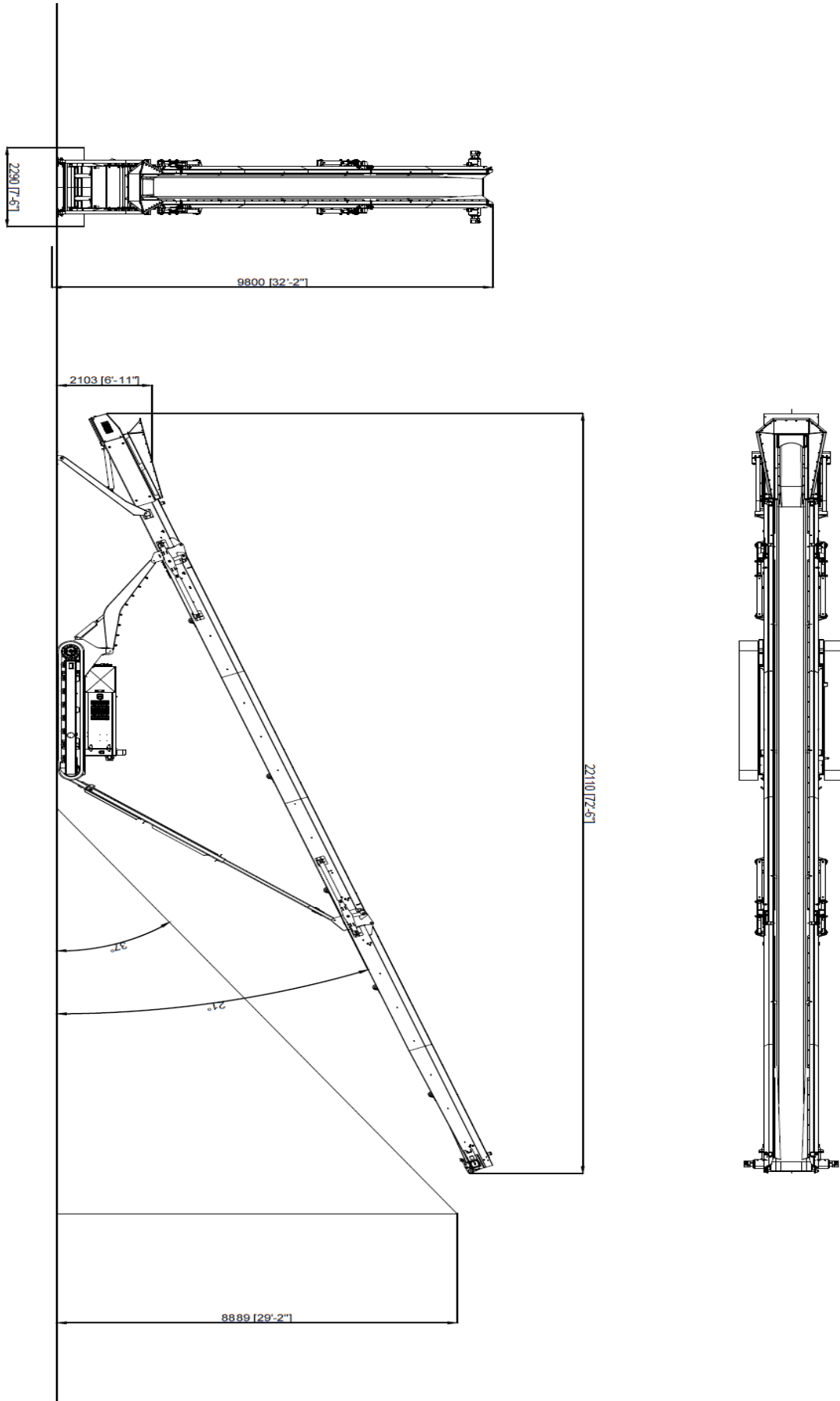

## TS4080

OCT.2016.issue 000

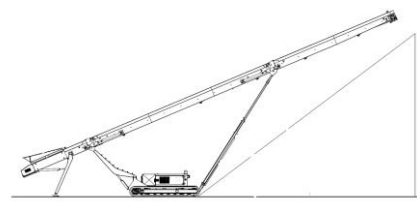

WEIGHT OF STANDARD  
MACHINE: 12700 KG

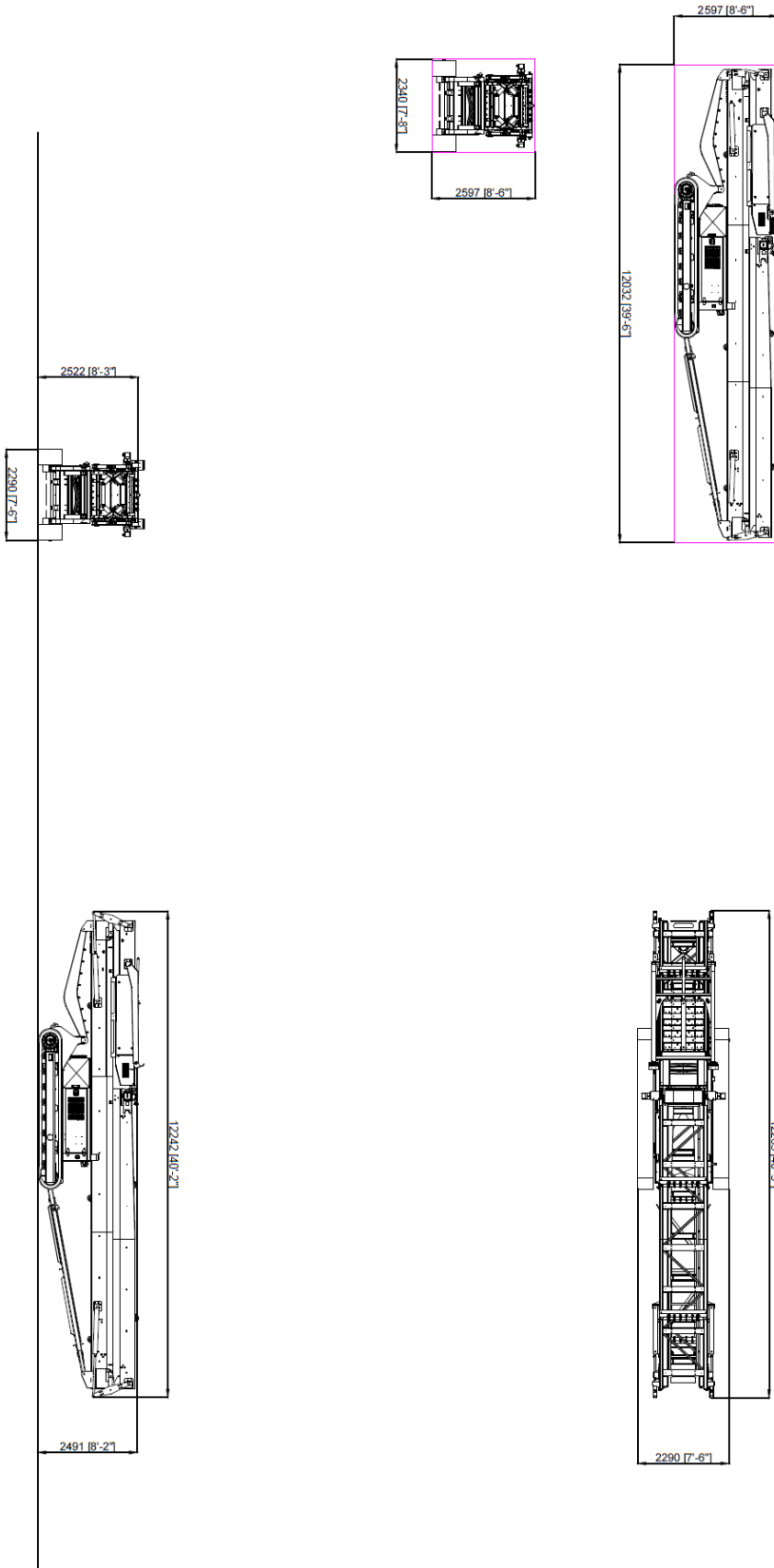

## TS4080

OCT.2016.issue 000

